

# LAQUA Twin pH Meter

## PRODUCT MANUAL

Item # 2103AL



**Spectrum<sup>®</sup>**  
**Technologies, Inc.**

This manual will familiarize you with the features and operation of your new meter. Please read this manual thoroughly before using your meter. For customer support or to place an order call:

Spectrum Technologies, Inc.  
(800)248-8873 or (815) 436-4440  
between 7:30 am and 5:30 pm CST  
FAX (815) 436-4460,  
e-mail: [info@specmeters.com](mailto:info@specmeters.com)  
[www.specmeters.com](http://www.specmeters.com)  
Spectrum Technologies, Inc  
12360 S. Industrial Dr. East  
Plainfield, IL 60585

### **Replacement Parts:**

**Item 2110**—Refill Solutions—pH4 and 7, 60 mL ea.

**Item 2143L**—LAQUA Twin pH Replacement Sensor

# GENERAL OVERVIEW

---

Thank you for purchasing the LAQUA Twin pH Meter from Spectrum Technologies. This meter is ideal for testing irrigation water, pesticide water or dairy rumen pH.

Features:

- “Professional Grade” Meter
- The dual-action sensor guard protects the electrode and captures samples from buckets and bodies of water
- Waterproof pocket-sized meter with digital calibration
- Flat sensor allows measurement of small samples
- Auto calibrates to pH 4 and 7 standard solutions
- Sensor is replaceable and stores dry
- Automatic temperature compensation, waterproof, auto power-off
- pH range: 2.0 to 12.0 (Accuracy/ Repeatability:  $\pm 0.1$  pH)
- Includes case, two CR2032 and pH 4 & 7 standards

The following two pages contain the quick start guide to help you get started. Following that is the manual produced by the manufacturer of the LAQUA Twin pH Meter. The meter you have purchased is model B-713.

# Quick Operation Guide

This quick operation guide introduces the basic operations.  
Refer to the respective chapters for further information.

## ① Turn ON

Press the ON/OFF button over 2 seconds to turn ON the meter.

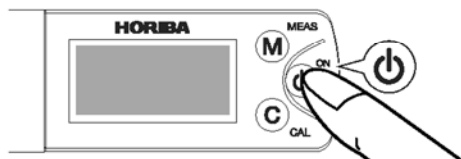

## ② Calibration

Perform calibration at least once a day for accurate measurement.

① Pour the pH 7 standard solution.

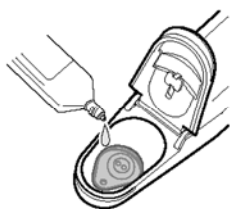

② Close the light shield cover.

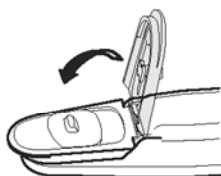

③ Press the CAL button over 2 seconds.

When **CAL** and ☺ light up, the calibration is completed.



④ Clean the sensor with water.



⑤ Press the MEAS button to enter the measurement mode.



### ③ Measurement

① Pour some drops of sample.



② Close the light shield cover.

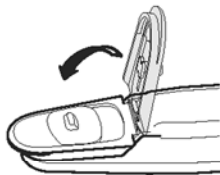

③ When ☺ lights up, the measurement is completed.  
To lock the measured value, press the MEAS button.



### ④ After Use

Clean the sensor with water,  
and then turn OFF the power.

Close the light shield cover before storage.

Make sure to store the sensor without any moisture.

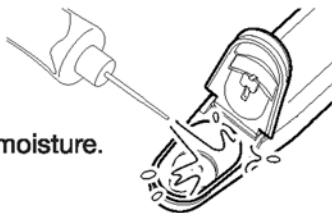

The following settings can be changed.

- Calibration mode (only for B-712 and B-713)
- Temperature/sensor voltage display
- Display digit (only for B-712 and B-713)

Two-point calibration is recommended for accurate measurement.  
Prewashing the sensor with the sample may provide accurate measurement.

Refer to page 6 to page 22 for detailed instructions.

# Contents

---

<b>1</b>	<b>Introduction</b> .....	<b>1</b>
1.1	Items in package .....	1
1.2	Consumable parts sold separately .....	1
<b>2</b>	<b>Part Names and Functions</b> .....	<b>2</b>
<b>3</b>	<b>Handling Precautions</b> .....	<b>4</b>
<b>4</b>	<b>Basic Handling</b> .....	<b>6</b>
4.1	Inserting/removing batteries .....	6
4.2	Attaching/detaching the sensor .....	7
4.3	Power ON/OFF .....	8
4.4	Storage .....	8
<b>5</b>	<b>Calibration</b> .....	<b>9</b>
5.1	About calibration .....	9
5.2	One-point calibration at pH 7 (B-711/B-712/B-713) .....	10
5.3	One-point calibration at pH 4 (B-712/B-713) .....	10
5.4	Two-point calibration (B-712/B-713) .....	11
<b>6</b>	<b>Measurement</b> .....	<b>12</b>
6.1	Sample setting .....	12
6.2	Measurement operations .....	15
<b>7</b>	<b>Special Setting Mode</b> .....	<b>16</b>
7.1	Temperature display mode .....	18
7.2	Calibration point setting (only for B-712/B-713) .....	19
7.3	Display digit setting (only for B-712/B-713) .....	20
7.4	Sensor voltage display mode .....	21
7.5	Initialization mode .....	22
7.6	Software version display mode .....	22
<b>8</b>	<b>Appendix</b> .....	<b>23</b>
8.1	Frequently asked questions .....	23
8.2	Specifications .....	25

# 1 Introduction

The COMPACT pH METER B-711, B-712, and B-713 incorporate HORIBA original flat sensor and enables accurate pH measurement from a single drop of a sample.

## 1.1 Items in package

Meter model		B-711	B-712	B-713
Sensor	S010	1	1	1
Meter	B-711	1	-	-
	B-712	-	1	-
	B-713	-	-	1
Storage case		1	1	1
Batteries	CR2032	2	2	2
Standard solutions	pH 4 (pH 4.01)	-	1	1
	pH 7 (pH 6.86)	1	1	-
	pH 7 (pH 7.00)	-	-	1
Pipette		1	1	1
Sampling sheet B	5 sheets	1	1	1
Instruction manual	Common to all model	1	1	1
Quick-start manual		1	1	1

## 1.2 Consumable parts sold separately

Part No.	Name	Type	Application
3200459834	Sensor	S010, pH	B-711, B-712, B-713
3200457725	Standard solutions	Y017, pH 6.86	B-711, B-712 (pH 7)
3200457726		Y014, pH 4.01	B-712, B-713 (pH 4)
3200459736	Sampling sheet holder cover	Y048	B-711, B-712, B-713, B-721, B-722, B-731, B-741, B-742, B-743, B-751
3200053858	Sampling sheet B	Y046, 100 sheet-pack	B-711, B-712, B-713, B-721, B-722, B-731, B-741, B-742, B-743, B-751

## 2 Part Names and Functions

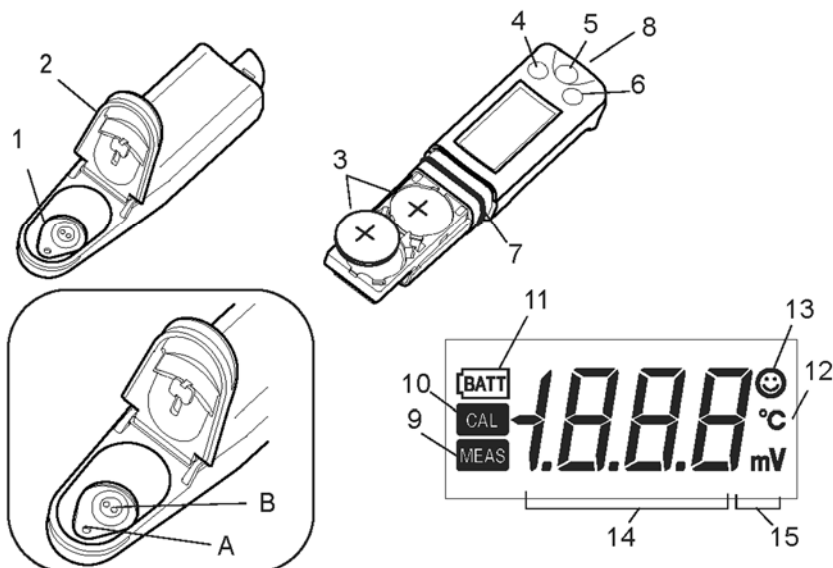

No.	Name	Description
1	Flat sensor	Place a sample on this sensor. This sensor consists of a liquid junction (A) and glass membrane (B). Both A and B must be covered with the sample.
2	Light shield cover	Shields the sensor from light, which affects the sensor. Close the light shield cover before starting measurement. If using the sampling sheet holder cover (refer to page 14), shield the flat sensor from light with an alternative.
3	Lithium batteries	CR2032 (×2)
4	MEAS switch	Switches the calibration mode to the measurement mode, activates/deactivates the reading locking function in the measurement mode, and starts/applies settings in the special setting mode.
5	ON/OFF switch	Turns ON/OFF the meter.
6	CAL switch	Starts calibration, and switches items/settings in the special setting mode.
7	Waterproof gasket	Makes the meter waterproof.



No.	Name	Description
8	Strap eyelet	A strap can be attached here.
9	MEAS icon	Blinks until the measured value is stabilized, and lights steadily when the measured value is settled, while the reading locking function is active.
10	CAL icon	Blinks during calibration, and lights steadily when calibration is finished.
11	Battery alarm icon	Lights up when the batteries are low and need to be changed.
12	Temperature alarm icon	Blinks when the measuring environment temperature does not meet the specified operating temperature (5°C to 40°C).
13	Stability icon	Lights up when the measured value is stabilized.
14	Measured value display	Displays a measured, set, or status value.
15	Measurement unit display	A unit symbol lights up corresponding to the value displayed on the measured value display (14). But no unit symbol lights up for a pH value.

### 3 Handling Precautions

#### ■ Meter and sensor

- The sensor is a consumable part. If it becomes damaged or its performance deteriorates, replace it with a new one (the sensor can not be repaired).
- Do not swing the meter and sensor by holding a strap.
- To ensure the waterproof performance, confirm the followings when attaching the sensor.
  - The waterproofing gasket is clean and undamaged.
  - The waterproofing gasket is seated properly in the groove with no twisting or warping.
  - The meter and sensor are not deformed.
- Neither the meter nor sensor is waterproof by itself. The sensor must be securely mounted on the meter before use.
- Do not drop the meter or apply excessive force to it.



- Do not leave the meter in areas of direct sunlight or high temperature/humidity.
- Do not clean the meter with organic solvents.



- The flat sensor is made of thin glass. Take care not to break it. If it is damaged, remove the sensor avoiding injury and dispose of it in a plastic bag.

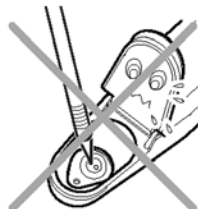
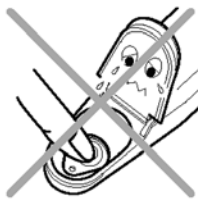

- Do not measure samples such as the following, since they may damage the sensor or shorten its life: Organic solvents, oils, adhesives, cement, alcohols, concentrated acid (0 pH to 2 pH), concentrated alkaline (12 pH to 14 pH) or surfactants.
- When using this product for the first time or after several days of disuse, the sensor may be slow to respond. In this case, add some drops of pH 7 standard solution to the sensor and wait a few hours before use (there is no need to turn the power ON).
- For some sample types (such as pure water), the measured value may be unstable.
- A small amount of liquid or white powder may appear on the liquid junction of the flat sensor. The appearance of this powder or solution is normal. Simply rinse it off with water before use.

## **Battery**

- Keep batteries out of reach of children. If someone accidentally swallows a battery, call a doctor immediately.
- Do not throw batteries in fire.
- Do not attempt to recharge batteries.
- The provided batteries are intended for use in operation checking, therefore their service life may be short.
- The battery alarm icon lights up when the battery voltage is low. Replace the batteries when the battery alarm icon lights up. The meter power may not be turned ON/OFF when the battery voltage is low.
- Replace the 2 batteries at the same time.

## **Others**

- Wash off any calibration fluid that comes into contact with hands or other exposed skin. If fluid gets in eyes, rinse them immediately and see a doctor.

## 4 Basic Handling

### 4.1 Inserting/removing batteries

#### Note

- Turn OFF the meter before inserting/removing batteries.
- Always replace both batteries at once. Do not use old and new batteries together.

#### Inserting the batteries

1. Slide both batteries into the battery case as shown.

Be sure to use two CR2032 batteries, and put them with the plus sides (+) upwards.

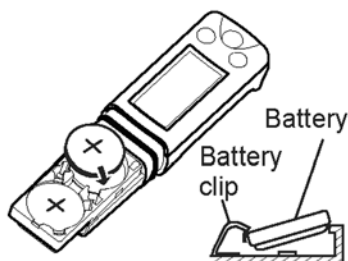

#### Removing the batteries

1. Use a ball-point pen or other tool to pry the batteries out from the clips as shown.

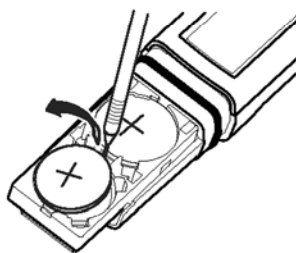

## 4.2 Attaching/detaching the sensor

### Note

- Turn OFF the meter before attaching/detaching the sensor.
- If the meter is turned ON with the sensor detached, the battery alarm may light up. In this case, turn OFF the meter and attach the sensor, and then turn ON the meter again.

### Attaching the sensor

1. Confirm that the waterproofing gasket is clean and undamaged.
2. Slide the sensor onto the meter so that catch "A" on the back of the meter fits into hole "a" on the sensor tongue as shown.

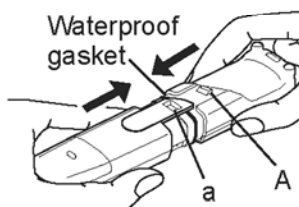

### Note

Be careful not to twist the waterproof gasket.

### Detaching the sensor

1. Lift the sensor tongue tip and slide the sensor a little away from the meter.
2. Pull out the sensor all the way from the meter.

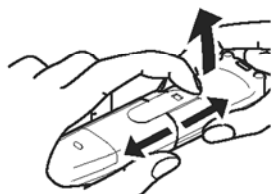

### Note

- Make sure that the sensor tongue is outside the meter case. If the tongue is inserted between the case and the connector of the meter, it may damage the connector.

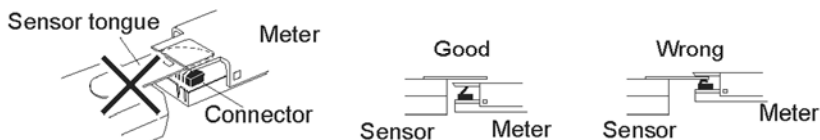

- When removing the sensor, do not let any water get inside the meter. If some moisture remains on the waterproof gasket, wipe it off carefully.

## 4.3 Power ON/OFF

### ■ Power ON

1. Press and hold the ON/OFF switch for over 2 seconds.

The power is turned ON, and the meter model number is displayed on the LCD.

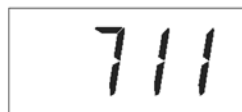
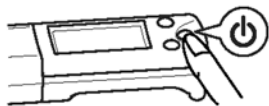

### ■ Power OFF

1. Press and hold the ON/OFF switch for over 2 seconds.

The power is turned OFF.

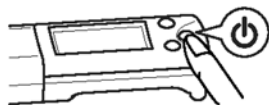

## 4.4 Storage

1. Clean the sensor with tap water and remove moisture on the sensor and meter with soft cloth or paper.

---

### Note

Do not push the flat sensor strongly. It may damage the sensor.

---

2. Close the light shield cover and the slide cap, then store the meter.

## 5 Calibration

### 5.1 About calibration

#### ■ Calibration points

The available calibration points depend on the meter models.

- One-point calibration at pH 7: B-711, B-712, B-713
- One-point calibration at pH 4: B-712, B-713
- Two-point calibration: B-712, B-713

“One-point calibration at pH 7” is set by default.

Refer to the instructions on page 19 for switching the calibration points (for B-712 and B-713 only).

The calibration point setting and calibration result are saved after the meter is turned OFF.

---

#### Tip

---

**For B-712 and B-713, two-point calibration is recommended especially if sample pH is outside 1 pH from the pH of the standard solution.**

---

#### ■ Precautions for calibration

- If **CAL** remains blinking and Err (error display) appears, the calibration is failed.

Check that the standard solution pH is correct, and perform calibration again after cleaning the sensor well.



- If the calibration is failed using correct standard solution(s), the sensor may be deteriorated. Replace the sensor with new one (part No.: 3200459834).
- In two-point calibration, confirm that the calibration operations are completed respectively for pH 7 and pH 4.  
The calibration operation for pH 4 can not start until the calibration for pH 7 is completed, and the whole calibration sequence is not completed until the calibration for pH 4.

## 5.2 One-point calibration at pH 7 (B-711/B-712/B-713)

1. (For B-712 and B-713 only) Set “One-point calibration at pH 7” (refer to page 19).

2. Open the light shield cover and put some drops of the pH 7 standard solution on the flat sensor to cover the entire flat sensor.

Washing the sensor with the standard solution beforehand may provide more accurate calibration.

3. Close the light shield cover and press the CAL switch for over 2 seconds.

**CAL** and ☺ blink and the calibration value is displayed.

After the calibration is completed, **CAL** and ☺ stop blinking and light steadily.

4. Clean the sensor with tap water and remove moisture.
5. Press the MEAS switch for 0.5 seconds to enter the measurement mode and prepare for measurement.

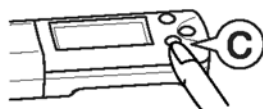

## 5.3 One-point calibration at pH 4 (B-712/B-713)

1. Set “One-point calibration at pH 4” (refer to page 19).

2. Open the light shield cover and put some drops of the pH 4 standard solution on the flat sensor to cover the entire flat sensor.

Washing the sensor with the standard solution beforehand may provide more accurate calibration.

3. Close the light shield cover and press the CAL switch for over 2 seconds.

**CAL** and ☺ blink and the calibration value is displayed.

After the calibration is completed, **CAL** and ☺ stop blinking and light steadily.

4. Clean the sensor with tap water and remove moisture.
5. Press the MEAS switch for 0.5 seconds to enter the measurement mode and prepare for measurement.

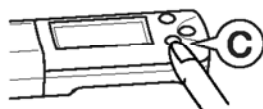



## 5.4 Two-point calibration (B-712/B-713)

1. Set “Two-point calibration” (refer to page 19).
2. Open the light shield cover and put some drops of the pH 7 standard solution on the flat sensor to cover the entire flat sensor.

Washing the sensor with the standard solution beforehand may provide more accurate calibration.

3. Close the light shield cover and press the CAL switch for over 2 seconds.

**CAL** and ☺ blink and the calibration value is displayed.

After the calibration is completed, **CAL** and ☺ stop blinking and light steadily.

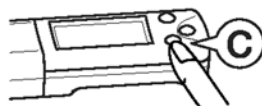

4. After the calibration for pH 7 is completed, open the light shield cover to remove the pH 7 standard solution and remove moisture on the sensor.

5. Put some drops of the pH 4 standard solution on the flat sensor to cover the entire flat sensor.

Washing the sensor with the standard solution beforehand may provide more accurate calibration.

6. Close the light shield cover and press the CAL switch for over 2 seconds.

**CAL** and ☺ blink and the calibration value is displayed.

After the calibration is completed, **CAL** and ☺ stop blinking and light steadily.

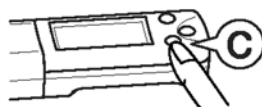

7. Clean the sensor with tap water and remove moisture.
8. Press the MEAS switch for 0.5 seconds to enter the measurement mode and prepare for measurement.

## 6 Measurement

### 6.1 Sample setting

The following 4-type sampling setting methods are available.

- Drop: for a small-amount sample
- Immersion: for a large-amount sample
- Scooping: for sampling a part of a sample
- Sampling sheet: for a sample containing tiny particles

#### Note

Although this product is waterproof, avoid immersing it completely. If the product is accidentally dropped into water, take it out of water and remove the moisture on it.

#### Drop

1. Open the light shield cover and put some drops of sample on the flat sensor to cover the entire flat sensor.
2. Close the light shield cover.

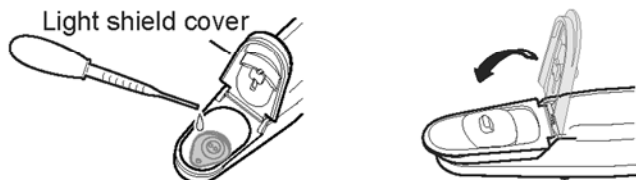

#### Tip

Try to use the provided sampling sheet B for a minute sample.

Using this sheet, the entire flat sensor can be covered with only 50  $\mu\text{L}$  to 100  $\mu\text{L}$  sample.

- Note that a reaction between a sample and the sampling sheet B may affect the measured value.
- Handle the sampling sheet B with tweezers to minimize possible contamination.
- Make sure to close the light shield cover during measurement to minimize possible sample evaporation.

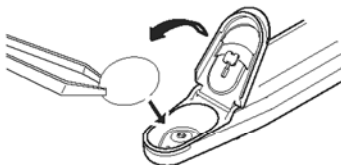

## ■ Immersion

1. Open the sliding cap on the light shield cover.
2. Immerse the sensor into the sample and stir gently 2 or 3 times.

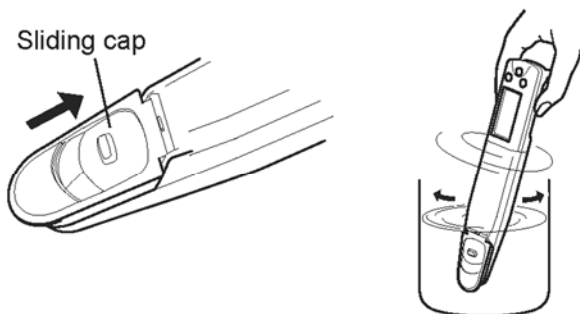

## ■ Scooping

1. Open the sliding cap on the light shield cover.
2. Immerse the sensor into the sample and stir gently 2 or 3 times, and then scoop up some of the sample with the sensor.
3. Place the meter flat and confirm that the sample covers the entire flat sensor.
4. Close the light shield cover.

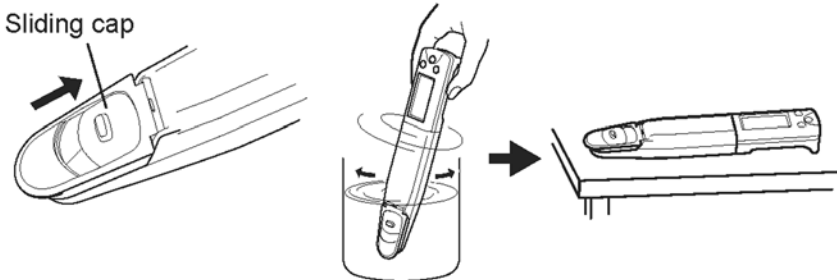

## ■ Sampling sheet

If tiny particles are contained in a sample, such as an extract from soil, the particles influence measurement results. Use the sampling sheet holder cover (part No. 3200459736) and sampling sheet B (part No. 3200053858) sold separately to counteract the influence.

1. Replace the light shield cover with the sampling sheet holder cover.
2. Put a piece of sampling sheet B on the flat sensor and close the sampling sheet holder cover.
3. Put 4 or 5 drops of sample on the sampling sheet B.

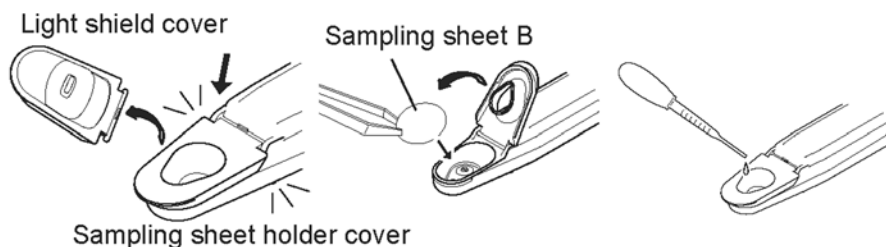

---

### Note

The sampling sheet holder cover does not shield the sensor from light, which affects the sensor. When using the sampling sheet holder cover, shield the flat sensor from light with an alternative.

---

## 6.2 Measurement operations

### ■ Without using the reading locking function

1. Confirm that the meter is in the measurement mode, and set a sample on the sensor.
2. Read the displayed value when ☺ appears.



### ■ With using the reading locking function

1. Confirm that the meter is in the measurement mode, and set a sample on the sensor.
2. After ☺ appears, press the MEAS switch for 0.5 seconds.

The reading locking function is activated.

**MEAS** blinks until the measured value is stabilized.

When the measured value is settled, **MEAS** stops blinking and the displayed value is locked with **MEAS** and ☺ lighting steadily.



3. Read the displayed value.
4. Press the MEAS switch for 0.5 seconds.

The reading locking function is deactivated and **MEAS** disappears.

---

#### Note

- If a measurement result is out of the specified measurement range, the displayed measured value blinks.
  - When using the reading locking function, deactivate the function before starting every measurement.
-

## 7 Special Setting Mode

The special setting mode enables the meter setting and special operations. To enter the special setting mode, press and hold the MEAS switch for over 3 seconds in the measurement mode. All the LCD items appear, then the meter enters the special setting mode.

### Tip

To exit the special setting mode with no setting change, press the ON/OFF switch to turn OFF and ON again.



All items appear.

\* Pressing the CAL switch continuously switches the display in turn.

↓ Automatically



MEAS switch →

"7.1 Temperature display mode" (page 18)  
Displays the ambient temperature measured using an internal temperature sensor.

↓ CAL switch\*



MEAS switch →

"7.2 Calibration point setting (only for B-712/B-713)" (page 19)  
Used to select the calibration points.

↓ CAL switch\*



MEAS switch →

"7.3 Display digit setting (only for B-712/B-713)" (page 20)  
Used to select the coefficient (0.01 to 9.90) for multiplying compensation. The values after compensation are displayed as results. The initial setting is 1.00.

↓ CAL switch\*



MEAS switch →

"7.4 Sensor voltage display mode" (page 21)  
Displays the voltage output from the sensor.

↓ CAL switch\*



MEAS switch →

"7.5 Initialization mode" (page 22)  
All settings and calibration data are reset to the factory default values.

↓ CAL switch\*



CAL switch\*

Returns to the display for temperature display mode.

**"7.6 Software version display mode" (page 22)**

The current software version is displayed.

## 7.1 Temperature display mode

Displays the ambient temperature measured with the internal temperature sensor. The measurement accuracy is unwarranted. Use the value only as a guide.

- 1. Press and hold the MEAS switch for over 3 seconds in the measurement mode to enter the special setting mode.**

All items appear on the LCD, and then the display changes as shown right.



- 2. Press the MEAS switch for 0.5 seconds.**

The ambient temperature measured using an internal temperature sensor is displayed.

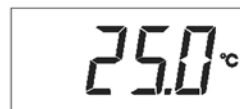

- 3. Press the MEAS switch to return the measurement mode.**



## 7.2 Calibration point setting (only for B-712/B-713)

Used to select the calibration points.

1. Press and hold the MEAS switch for over 3 seconds in the measurement mode to enter the special setting mode.

All items appear on the LCD, and then the display changes as shown right.



2. Press the CAL switch until CAL appears.



3. Press the MEAS switch for 0.5 seconds.

The current setting is displayed.

4. Press the CAL switch for 0.5 seconds to change the setting.

Pressing the CAL switch continuously switches the display in turn.

One-point calibration  
at pH 7



Press the CAL switch  
for 0.5 seconds.

Two-point calibration

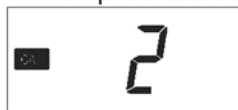

Press the CAL switch  
for 0.5 seconds.

One-point calibration  
at pH 4



Press the CAL switch  
for 0.5 seconds.

5. Press the MEAS switch to apply the setting.

The measurement mode is returned.

### 7.3 Display digit setting (only for B-712/B-713)

Used to select the display digit (One or two decimal places) for measured value.

The initial setting is one decimal place.

1. Press and hold the MEAS switch for over 3 seconds in the measurement mode to enter the special setting mode.

All items appear on the LCD, and then the display changes as shown right.



2. Press the CAL switch until MEAS appears.



3. Press the MEAS switch for 0.5 seconds.

The current setting is displayed.

4. Press the CAL switch for 0.5 seconds to change the setting.

One decimal place

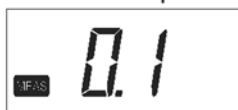

Press the CAL switch for 0.5 seconds.



Two decimal places



5. Press the MEAS switch to apply the setting.

The measurement mode is returned.

## 7.4 Sensor voltage display mode

Displays the voltage output from the sensor.

Use this function to evaluate the sensor performance or to create your own calibration line or curve.

1. **Press and hold the MEAS switch for over 3 seconds in the measurement mode to enter the special setting mode.**

All items appear on the LCD, and then the display changes as shown right.



2. **Press the CAL switch until mV appears.**



3. **Press the MEAS switch for 0.5 seconds.**

The voltage output from the sensor is displayed.

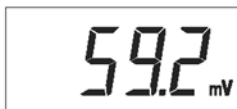

4. **Press the MEAS switch to return the measurement mode.**

## 7.5 Initialization mode

All settings and all calibration data are reset to the factory default values.

1. Press and hold the MEAS switch for over 3 seconds in the measurement mode to enter the special setting mode.

All items appear on the LCD, and then the display changes as shown right.



2. Press the CAL switch until Init appears.



3. Press the MEAS switch for 0.5 seconds.

☺ appears.



4. Press the CAL switch for over 2 seconds.

All settings and all calibration data are reset to the factory default values.

When initialization is completed, End and ☺ appear.



5. Press the ON/OFF switch to turn OFF and ON again.

## 7.6 Software version display mode

The current software version is displayed.

This information may be asked for depending on your inquiry.

1. Press and hold the MEAS switch for over 3 seconds in the measurement mode to enter the special setting mode.

All items appear on the LCD, and then the display changes as shown right.



2. Press the CAL switch until Init appears.



3. Press the CAL switch for 0.5 seconds.

The software version is displayed.



## 8 Appendix

### 8.1 Frequently asked questions

Question	Answer
How long is the sensor's service life?	It depends on measurement samples and conditions. It should be approx. 1500 measurements for typical samples. Note that sensor deterioration and failure are not included in the warranty.
How can I check the sensor's condition?	For B-712 and B-713, perform two-point calibration. If calibration error occurs, the sensor is deteriorated. Replace the sensor. For B-711, measure the pH 4.01 standard solution (part No. 3200457726) sold separately after calibration, and check how much the measured pH value drifts from the specified pH. If the measured value drifts, the sensor is deteriorated. Replace the sensor.
Are there any helpful tips or precautions to be aware for measurement?	Use the light shield cover to avoid direct sunlight during measurement because the sensor is affected by light.
	When the sample amount is enough, washing the sensor twice or so with the sample allows more accurate measurement.
	Residue between the light shield cover and flat sensor prevents accurate measurement. Before measurement of the next sample, clean the sensor with tap water and remove moisture.
Can I measure high- or low-temperature samples?	This product can not measure a sample with a temperature outside the meter's operating temperature range (5°C to 40°C). The difference between the sample temperature and ambient temperature increases the measurement error. Perform measurement after the sample reaches the ambient temperature.
The measured value does not change after changing the sample.	If <b>MEAS</b> lights steadily, the measured value is locked. Press the MEAS switch to unlock the value. If the value does not change after unlocking, the sensor may be damaged. Replace the sensor.
"0.0" blinks in pH measurement.	The measured pH may be out of the specified measurement range (2 pH to 12 pH). Measure a standard solution to check, and if "0.0" blinks even then, replace the sensor.
The temperature alarm icon blinks during measurement.	The measuring environment temperature may not meet the specified operating temperature (5°C to 40°C). When the environment temperature is within the specified range and the alarm icon blinks, replace the sensor.

Question	Answer
The power is not turned ON.	Check that the batteries are inserted properly. If the batteries are low, replace them both with new ones at the same time.
Er1 is displayed right after power ON.	The internal IC in the meter may defect. After Er1 is displayed, the meter enters the initialization mode automatically and InIt and ☺ appear. Press the CAL switch for over 2 seconds to execute initialization, and then turn OFF and ON again (refer to page 22). If Er1 is still displayed after the initialization, the internal IC in the meter defects. Replace the product with new one (the meter can not be repaired).
Er2 is displayed right after power ON.	The internal IC in the meter defects. Replace the product with new one (the meter can not be repaired).
Er3 is displayed right after power ON.	The internal IC in the meter defects. Replace the product with new one (the meter can not be repaired).
How can I return all the settings of the special setting mode to the default settings?	Perform initialization (refer to page 22).

## 8.2 Specifications

Model		B-711	B-712	B-713 (US only)
Measurement principle		Glass electrode method		
Minimum sample volume		0.1 mL or more <sup>*1</sup>		
Measurement range	pH	2 pH to 12 pH		
Display range		0 pH to 14 pH <sup>*2</sup>		
Resolution (valid digits)		0.1 pH	0.1 pH or 0.01 pH (selectable)	
Calibration		One-point	Two-point <sup>*3</sup>	
Accuracy		±0.1 pH <sup>*4</sup>		
Display		Custom (monochrome) digital LCD		
Operating temperature/humidity		5°C to 40°C, 85% or less in relative humidity (no condensation)		
Power		CR2032 batteries (×2)		
Battery life		Approx. 400 hours in continuous use		
Main materials		ABS epoxy		
Outer dimensions/mass		164 mm × 29 mm × 20 mm (excluding projections), Approx. 50 g (meter only, without batteries)		
Main functions		Temperature compensation, waterproof <sup>*5</sup> , reading locking, automatic power OFF		

\*1 0.05 mL or more if the sampling sheet B is used.

\*2 When the measured value is out of the measurement range, the displayed value blinks. It should be used only as a guide.

\*3 Selectable between one-point and two-point calibrations.

\*4 Repeatability in measurement of a standard solution after calibration using the same standard solution

\*5 IP67: no failure when immersed in water at a depth of 1 meter for 30 minutes. But the product can not be used underwater.

# WARRANTY

---

This product is warranted to be free from defects in material or workmanship for one year from the date of purchase. During the warranty period Spectrum will, at its option, either repair or replace products that prove to be defective. This warranty does not cover damage due to improper installation or use, lightning, negligence, accident, or unauthorized modifications, or to incidental or consequential damages beyond the Spectrum product. Before returning a failed unit, you must obtain a Returned Materials Authorization (RMA) from Spectrum. Spectrum is not responsible for any package that is returned without a valid RMA number or for the loss of the package by any shipping company.



The Manufacturer's **DECLARATION OF CONFORMITY** certifies conformity to the following:

Model Number:	2103AL
Description:	LAQUA Twin pH Meter
Type:	Portable Test and Measurement Equipment
Directive:	2004/108/EC
Standards:	EN 61326-1 (2006), Class B

***Spectrum***<sup>®</sup>  
***Technologies, Inc.***

12360 S. Industrial Dr. E  
Plainfield IL 60585  
(800) 248-8873 or (815) 436-4440  
Fax (815) 436-4460  
E-Mail: [info@specmeters.com](mailto:info@specmeters.com)  
[www.specmeters.com](http://www.specmeters.com)