

LAQUA Twin Potassium K⁺ Meter

PRODUCT MANUAL

Item # 2400GL



Spectrum[®]
Technologies, Inc.

This manual will familiarize you with the features and operation of your new meter. Please read this manual thoroughly before using your meter. For customer support or to place an order call:

Spectrum Technologies, Inc.
(800)248-8873 or (815) 436-4440
between 7:30 am and 5:30 pm CST
FAX (815) 436-4460,
e-mail: info@specmeters.com
www.specmeters.com
Spectrum Technologies, Inc
3600 Thayer Court
Aurora, IL 60504

GENERAL OVERVIEW

Thank you for purchasing the LAQUA Twin Potassium K+ Meter from Spectrum Technologies.

Features:

- “Professional Grade” Meter
- Measure nutrient solutions, soils, greenhouses soilless media, water samples and tissue sap
- Waterproof pocket-sized meter with digital calibration
- Sensors store dry and are field replaceable
- Accuracy correlates well with laboratory analysis
- Automatic temperature compensation, waterproof, auto power-off
- Includes two CR2032 batteries, case calibration standards

The following two pages contain the quick start guide to help you get started. Following that is the manual produced by the manufacturer of the LAQUA Twin Potassium K+ Meter.

Quick Operation Guide

This quick operation guide introduces the basic operations.
Refer to the respective chapters for further information.

① Turn ON

Press the ON/OFF button over 2 seconds to turn ON the meter.

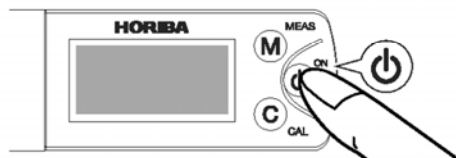

② Calibration

Perform calibration at least once a day for accurate measurement.

- ① Pour the 2000 ppm standard solution. ② Close the light shield cover.

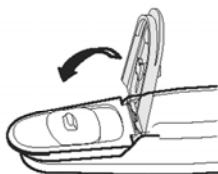
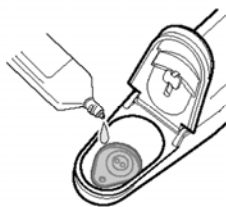

- ③ Press the CAL button over 2 seconds.
When **CAL** and ☺ light up, the calibration is completed.



- ④ Clean the sensor with water.



- ⑤ Press the MEAS button to enter the measurement mode.



③ Measurement

① Pour some drops of sample.



② Close the light shield cover.

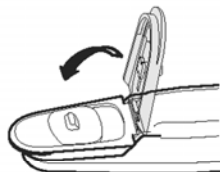

③ When ☺ lights up, the measurement is completed.
To lock the measured value, press the MEAS button.



④ After Use

Clean the sensor with water,
and then turn OFF the power.

Close the light shield cover before storage.

Make sure to store the sensor without any moisture.

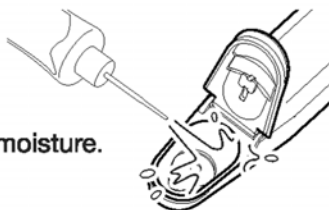

The following settings can be changed.

- Measurement unit · Calibration points
- Temperature/sensor voltage display
- Multiplying/adding compensation · Calibration value

Two-point calibration is recommended for accurate measurement.
Prewashing the sensor with the sample may provide accurate measurement.

Refer to page 6 to page 25 for detailed instructions.

Contents

1	Introduction	1
1.1	Items in package	1
1.2	Consumable parts sold separately	1
2	Part Names and Functions	2
3	Handling Precautions	4
4	Basic Handling	6
4.1	Inserting/removing batteries	6
4.2	Attaching/detaching the sensor	7
4.3	Power ON/OFF	8
4.4	Storage	8
5	Calibration	9
5.1	About calibration	9
5.2	One-point calibration in high concentration	10
5.3	One-point calibration in low concentration	10
5.4	Two-point calibration	11
6	Measurement	12
6.1	Sample setting	12
6.2	Measurement operations	15
7	Special Setting Mode	16
7.1	Measurement unit setting	18
7.2	Temperature display mode	19
7.3	Calibration point setting	20
7.4	Multiplying compensation setting	21
7.5	Adding compensation setting	22
7.6	Sensor voltage display mode	23
7.7	Low calibration value setting	24
7.8	Initialization mode	25
7.9	Software version display mode	25
8	Appendix	26
8.1	Frequently asked questions	26
8.2	Specifications	28
8.3	Interfering ions	29
	Soil Test Instructions	30
	Petiole Potassium Sufficiency Levels	32

1 Introduction

The COMPACT K⁺ METER B-731 incorporates HORIBA original flat sensor and enables accurate measurement of potassium ion (K⁺) concentrations from a single drop of a sample.

1.1 Items in package

Meter model		B-731
Sensor	S030	1
Meter	B-731	1
Storage case		1
Batteries	CR2032	2
Dedicated standard solutions	K ⁺ 150 ppm	1
	K ⁺ 2000 ppm	1
Pipette		1
Sampling sheet B	5 sheets	1
Instruction manual	B-731	1
Quick-start manual		1

Consumable parts sold separately:

Item 2440L - Replacement Potassium sensor

Item 2414L - 150 ppm K⁺ DI Standard, 6 - 14 mL bottles

Item 2418L - 2000 ppm K⁺DI Standard, 6—14 mL bottles

Item 2434 - Soil K⁺ Soil Test Kit w/30 Samples

Item 2135 - Sampling Sheets - 5 Rolls

2 Part Names and Functions

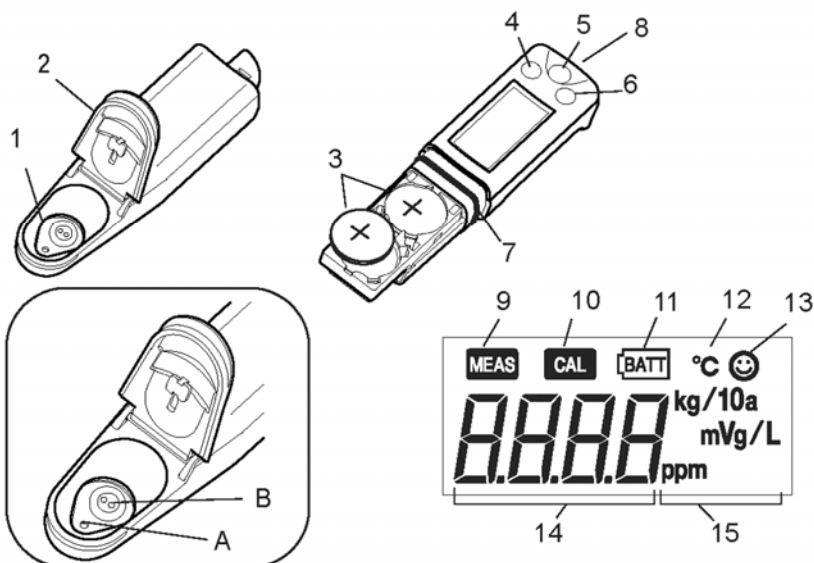

No.	Name	Description
1	Flat sensor	Place a sample on this sensor. This sensor consists of a liquid junction (A) and response membrane (B). Both A and B must be covered with the sample.
2	Light shield cover	Shields the sensor from light, which affects the sensor. Close the light shield cover before starting measurement. If using the sampling sheet holder cover (refer to page 14), shield the flat sensor from light with an alternative.
3	Lithium batteries	CR2032 (×2)
4	MEAS switch	Switches the calibration mode to the measurement mode, activates/deactivates the reading locking function in the measurement mode, and starts/applies settings in the special setting mode.
5	ON/OFF switch	Turns ON/OFF the meter.
6	CAL switch	Starts calibration, and switches items/settings in the special setting mode.
7	Waterproof gasket	Makes the meter waterproof.

No.	Name	Description
8	Strap eyelet	A strap can be attached here.
9	MEAS icon	Blinks until the measured value is stabilized, and lights steadily when the measured value is settled, while the reading locking function is active.
10	CAL icon	Blinks during calibration, and lights steadily when calibration is finished.
11	Battery alarm icon	Lights up when the batteries are low and need to be changed.
12	Temperature alarm icon	Blinks when the measuring environment temperature does not meet the specified operating temperature (5°C to 40°C).
13	Stability icon	Lights up when the measured value is stabilized.
14	Measured value display	Displays a measured, set, or status value.
15	Measurement unit display	A unit symbol lights up corresponding to the value displayed on the measured value display (14). For potassium ion concentrations, "ppm", "mg/L", or "kg/10a" is selectable (refer to page 18). The default setting is "ppm".

3 Handling Precautions

■ Meter and sensor

- The sensor is a consumable part. If it becomes damaged or its performance deteriorates, replace it with a new one (the sensor can not be repaired).
- Do not swing the meter and sensor by holding a strap.
- To ensure the waterproof performance, confirm the followings when attaching the sensor.
 - The waterproofing gasket is clean and undamaged.
 - The waterproofing gasket is seated properly in the groove with no twisting or warping.
 - The meter and sensor are not deformed.
- Neither the meter nor sensor is waterproof by itself. The sensor must be securely mounted on the meter before use.
- Do not drop the meter or apply excessive force to it.



- Do not leave the meter in areas of direct sunlight or high temperature/humidity.
- Do not clean the meter with organic solvents.



- Take care not to scratch the flat sensor.

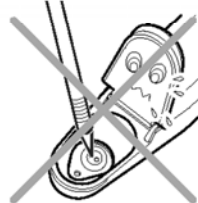
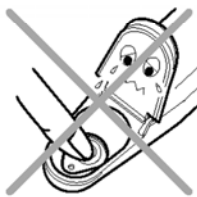

- Store the response membrane of the flat sensor in dry conditions. If the response membrane gets wet for a long time, it may become deformed.
- Do not measure samples such as the following, since they may damage the sensor or shorten its life: Organic solvents, oils, adhesives, cement, alcohols, concentrated acid (0 pH to 2 pH), concentrated alkaline (12 pH to 14 pH) or surfactants.
- When using this product for the first time or after several weeks of disuse, the sensor may be slow to respond. In this case, add some drops of 2000 ppm standard solution to the sensor and wait 10 minutes to an hour before use (there is no need to turn the power ON).
- For some sample types (such as highly oily samples), the measured value may be unstable.
- A small amount of liquid or white powder may appear on the liquid junction of the flat sensor. The appearance of this powder or solution is normal. Simply rinse it off with water before use.

Battery

- Keep batteries out of reach of children. If someone accidentally swallows a battery, call a doctor immediately.
- Do not throw batteries in fire.
- Do not attempt to recharge batteries.
- The provided batteries are intended for use in operation checking, therefore their service life may be short.
- The battery alarm icon lights up when the battery voltage is low. Replace the batteries when the battery alarm icon lights up. The meter power may not be turned ON/OFF when the battery voltage is low.
- Replace the 2 batteries at the same time.

Others

- Wash off any calibration fluid that comes into contact with hands or other exposed skin. If fluid gets in eyes, rinse them immediately and see a doctor.
- Do not drink a sample after measurement. The response membrane of the flat sensor is made of PVC, and the plasticizer in PVC may seep into the sample used for measurement.

4 Basic Handling

4.1 Inserting/removing batteries

Note

- Turn OFF the meter before inserting/removing batteries.
- Always replace both batteries at once. Do not use old and new batteries together.

Inserting the batteries

1. Slide both batteries into the battery case as shown.

Be sure to use two CR2032 batteries, and put them with the plus sides (+) upwards.

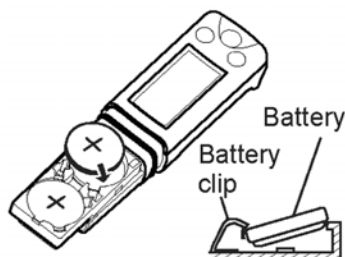

Removing the batteries

1. Use a ball-point pen or other tool to pry the batteries out from the clips as shown.

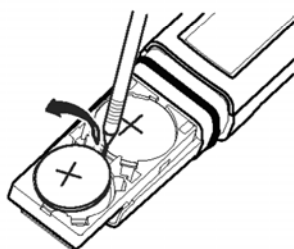

4.2 Attaching/detaching the sensor

Note

- Turn OFF the meter before attaching/detaching the sensor.
- If the meter is turned ON with the sensor detached, the battery alarm may light up. In this case, turn OFF the meter and attach the sensor, and then turn ON the meter again.

Attaching the sensor

1. Confirm that the waterproofing gasket is clean and undamaged.
2. Slide the sensor onto the meter so that catch "A" on the back of the meter fits into hole "a" on the sensor tongue as shown.

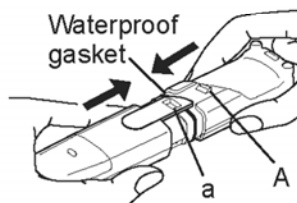

Note

Be careful not to twist the waterproof gasket.

Detaching the sensor

1. Lift the sensor tongue tip and slide the sensor a little away from the meter.
2. Pull out the sensor all the way from the meter.

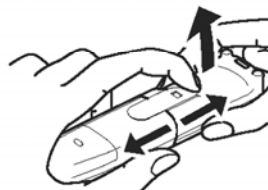

Note

- Make sure that the sensor tongue is outside the meter case. If the tongue is inserted between the case and the connector of the meter, it may damage the connector.

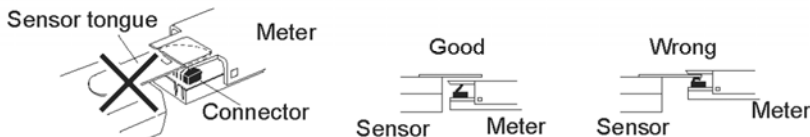

- When removing the sensor, do not let any water get inside the meter. If some moisture remains on the waterproof gasket, wipe it off carefully.

4.3 Power ON/OFF

■ Power ON

1. Press and hold the ON/OFF switch for over 2 seconds.

The power is turned ON, and the meter model number is displayed on the LCD.

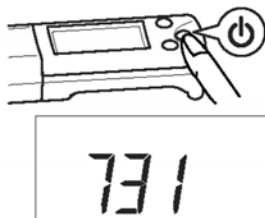

■ Power OFF

1. Press and hold the ON/OFF switch for over 2 seconds.

The power is turned OFF.

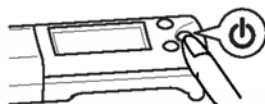

4.4 Storage

1. Clean the sensor with tap water and remove moisture on the sensor and meter with soft cloth or paper.
2. Close the light shield cover and the slide cap, then store the meter.

Note

Take care to store the sensor without moisture. Avoid to immerse the sensor into liquid for a long time.

5 Calibration

5.1 About calibration

■ Calibration points

The following 3-type calibrations are available.

- One-point calibration in high concentration:
for high concentration measurement
- One-point calibration in low concentration:
for low concentration measurement
- Two-point calibration:
for high accuracy measurement

“One-point calibration in high concentration” is set by default.

Refer to the instructions on page 20 for switching the calibration points.

The calibration point setting and calibration result are saved after the meter is turned OFF.

Tip

Two-point calibration is recommended especially if the concentrations of sample and standard solution differ by more than 10-fold.

■ Precautions for calibration

- If **CAL** remains blinking and Err (error display) appears, the calibration is failed.
Check that the standard solution concentration is correct, and perform calibration again after cleaning the sensor well.
- If the calibration is failed using correct standard solution(s), the sensor may be deteriorated. Replace the sensor with new one (part No.: 3200459868).
- In two-point calibration, confirm that the calibration operations are completed respectively for low and high concentrations.
The calibration operation for high concentration can not start until the calibration for low concentration is completed, and the whole calibration sequence is not completed until the calibration for high concentration.

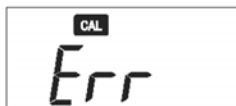

5.2 One-point calibration in high concentration

1. Set “One-point calibration in high concentration” (refer to page 20).
2. Open the light shield cover and put some drops of the high-concentration standard solution on the flat sensor to cover the entire flat sensor.
Washing the sensor with the standard solution beforehand may provide more accurate calibration.
3. Close the light shield cover and press the CAL switch for over 2 seconds.



CAL and ☺ blink and the calibration value is displayed.

After the calibration is completed, **CAL** and ☺ stop blinking and light steadily.

4. Clean the sensor with tap water and remove moisture.
5. Press the MEAS switch for 0.5 seconds to enter the measurement mode and prepare for measurement.

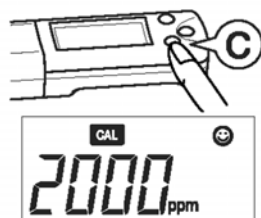

5.3 One-point calibration in low concentration

1. Set “One-point calibration in low concentration” (refer to page 20).
2. Open the light shield cover and put some drops of the low-concentration standard solution on the flat sensor to cover the entire flat sensor.
Washing the sensor with the standard solution beforehand may provide more accurate calibration.
3. Close the light shield cover and press the CAL switch for over 2 seconds.



CAL and ☺ blink and the calibration value is displayed.

After the calibration is completed, **CAL** and ☺ stop blinking and light steadily.

4. Clean the sensor with tap water and remove moisture.
5. Press the MEAS switch for 0.5 seconds to enter the measurement mode and prepare for measurement.

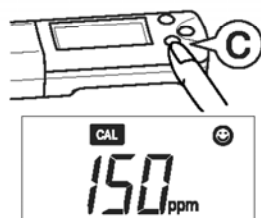

5.4 Two-point calibration

1. Set “Two-point calibration” (refer to page 20).
2. **Open the light shield cover and put some drops of the low-concentration standard solution on the flat sensor to cover the entire flat sensor.**
Washing the sensor with the standard solution beforehand may provide more accurate calibration.
3. **Close the light shield cover and press the CAL switch for over 2 seconds.**

CAL and ☺ blink and the calibration value is displayed.

After the calibration is completed, **CAL** and ☺ stop blinking and light steadily.

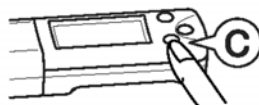

4. **After the calibration for low concentration is completed, open the light shield cover to remove the low-concentration standard solution and wipe off moisture on the sensor.**

5. **Put some drops of the high-concentration standard solution on the flat sensor to cover the entire flat sensor.**

Washing the sensor with the standard solution beforehand may provide more accurate calibration.

6. **Close the light shield cover and press the CAL switch for over 2 seconds.**

CAL and ☺ blink and the calibration value is displayed.

After the calibration is completed, **CAL** and ☺ stop blinking and light steadily.

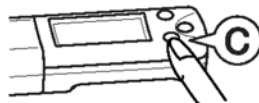

7. **Clean the sensor with tap water and remove moisture.**
8. **Press the MEAS switch for 0.5 seconds to enter the measurement mode and prepare for measurement.**

6 Measurement

6.1 Sample setting

The following 4-type sampling setting methods are available.

- Drop: for a small-amount sample
- Immersion: for a large-amount sample
- Scooping: for sampling a part of a sample
- Sampling sheet: for a sample containing tiny particles

Note

Although this product is waterproof, avoid immersing it completely. If the product is accidentally dropped into water, take it out of water and wipe off the moisture on it.

Drop

1. Open the light shield cover and put some drops of sample on the flat sensor to cover the entire flat sensor.
2. Close the light shield cover.

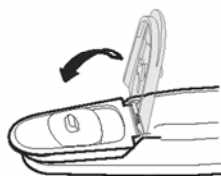

Tip

Try to use the provided sampling sheet B for a minute sample.

Using this sheet, the entire flat sensor can be covered with only 50 μL to 100 μL sample.

- Note that a reaction between a sample and the sampling sheet B may affect the measured value.
- Handle the sampling sheet B with tweezers to minimize possible contamination.
- Make sure to close the light shield cover during measurement to minimize possible sample evaporation.

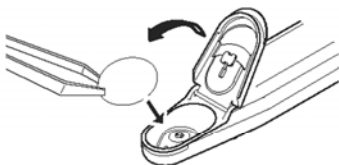

■ Immersion

1. Open the sliding cap on the light shield cover.
2. Immerse the sensor into the sample and stir gently 2 or 3 times.

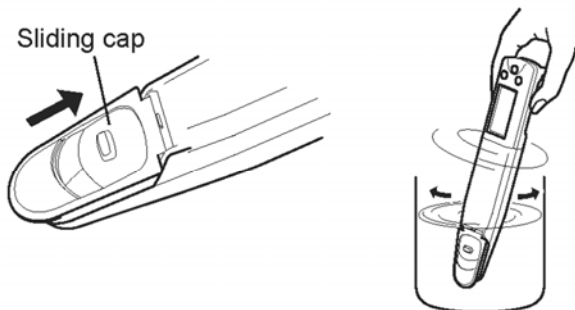

■ Scooping

1. Open the sliding cap on the light shield cover.
2. Immerse the sensor into the sample and stir gently 2 or 3 times, and then scoop up some of the sample with the sensor.
3. Place the meter flat and confirm that the sample covers the entire flat sensor.
4. Close the light shield cover.

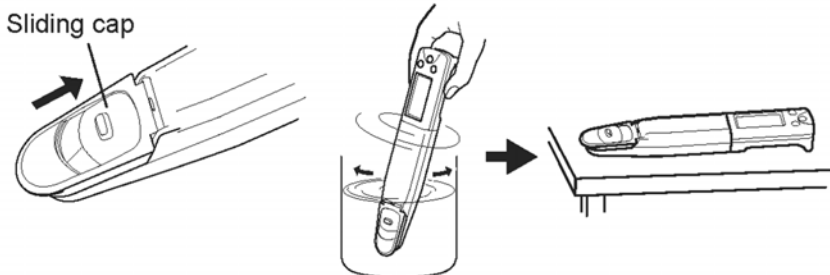

■ Sampling sheet

If tiny particles are contained in a sample, such as an extract from soil, the particles influence measurement results. Use the sampling sheet holder cover (part No. 3200459736) and sampling sheet B (part No. 3200053858) sold separately to counteract the influence.

1. Replace the light shield cover with the sampling sheet holder cover.
2. Put a piece of sampling sheet B on the flat sensor and close the sampling sheet holder cover.
3. Put 4 or 5 drops of sample on the sampling sheet B.

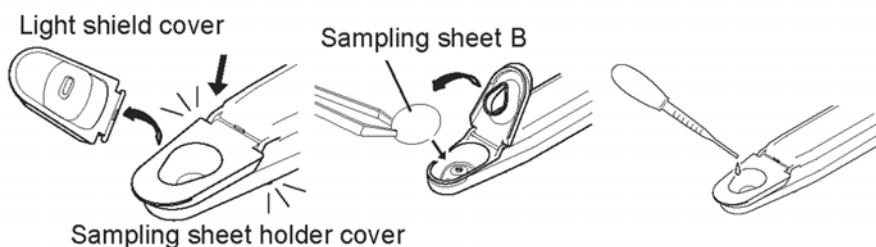

Note

The sampling sheet holder cover does not shield the sensor from light, which affects the sensor. When using the sampling sheet holder cover, shield the flat sensor from light with an alternative.

6.2 Measurement operations

■ Without using the reading locking function

1. Confirm that the meter is in the measurement mode, and set a sample on the sensor.
2. Read the displayed value when ☺ appears.



■ With using the reading locking function

1. Confirm that the meter is in the measurement mode, and set a sample on the sensor.
2. After ☺ appears, press the MEAS switch for 0.5 seconds.
The reading locking function is activated.
MEAS blinks until the measured value is stabilized.
When the measured value is settled, MEAS stops blinking and the displayed value is locked with MEAS and ☺ lighting steadily.
3. Read the displayed value.
4. Press the MEAS switch for 0.5 seconds.



Note

- If a measurement result is out of the specified measurement range, the displayed measured value blinks.
 - When using the reading locking function, deactivate the function before starting every measurement.
-

7 Special Setting Mode

The special setting mode enables the meter setting and special operations. To enter the special setting mode, press and hold the MEAS switch for over 3 seconds in the measurement mode. All the LCD items appear, then the meter enters the special setting mode.

Tip

To exit the special setting mode with no setting change, press the ON/OFF switch to turn OFF and ON again.



All items appear.

* Pressing the CAL switch continuously switches the display in turn.

↓ Automatically



MEAS switch →

"7.1 Measurement unit setting" (page 18)
Used to select measurement unit.

↓ CAL switch*



MEAS switch →

"7.2 Temperature display mode" (page 19)
Displays the ambient temperature measured using an internal temperature sensor.

↓ CAL switch*

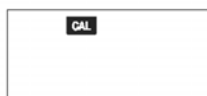

MEAS switch →

"7.3 Calibration point setting" (page 20)
Used to select the calibration points.

↓ CAL switch*



MEAS switch →

"7.4 Multiplying compensation setting" (page 21)
Used to select the coefficient (0.01 to 9.90) for multiplying compensation. The values after compensation are displayed as results. The initial setting is 1.00.

↓ CAL switch*



MEAS switch →

"7.5 Adding compensation setting" (page 22)
Used to select the coefficient (-1000 to 1000) for adding compensation. The values after compensation are displayed as results. The initial setting is 0.

↓ CAL switch*



MEAS
switch



"7.6 Sensor voltage display mode" (page 23)

Displays the voltage output from the sensor.

↓ CAL switch*

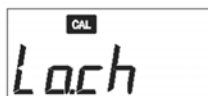

MEAS
switch



"7.7 Low calibration value setting" (page 24)

Used to change calibration value (39 ppm to 1900 ppm) for low concentration.

The initial setting is 150 ppm.

↓ CAL switch*

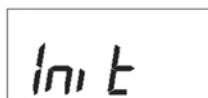

MEAS
switch



"7.8 Initialization mode" (page 25)

All settings and calibration data are reset to the factory default values.

↓ CAL switch*

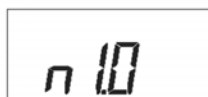

↓ CAL switch*

"7.9 Software version display mode" (page 25)

The current software version is displayed.

Returns to the display for measurement unit setting.

7.1 Measurement unit setting

Used to select measurement unit.

1. Press and hold the MEAS switch for over 3 seconds in the measurement mode to enter the special setting mode.

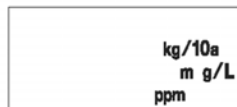

All items appear on the LCD, and then the display changes as shown above.

2. Press the MEAS switch for 0.5 seconds. The current setting is displayed.
3. Press the CAL switch for 0.5 seconds to change the setting. Pressing the CAL switch continuously switches the display in turn.

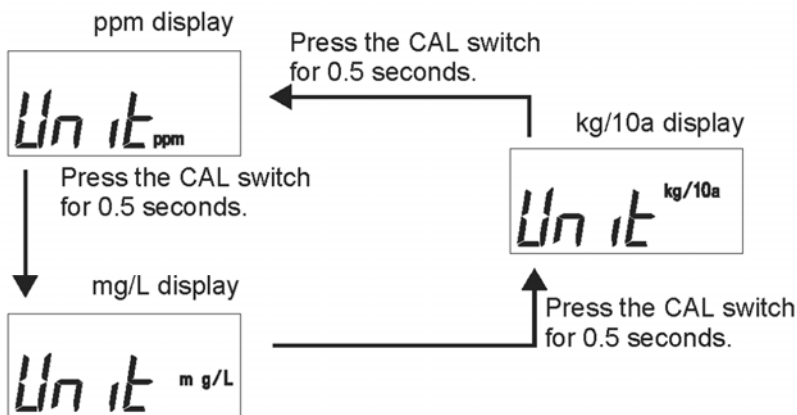

4. Press the MEAS switch to apply the setting. The measurement mode is returned.

7.2 Temperature display mode

Displays the ambient temperature measured with the internal temperature sensor. The measurement accuracy is unwarranted. Use the value only as a guide.

1. **Press and hold the MEAS switch for over 3 seconds in the measurement mode to enter the special setting mode.**

All items appear on the LCD, and then the display changes as shown right.

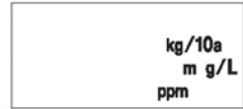

2. **Press the CAL switch until °C appears.**



3. **Press the MEAS switch for 0.5 seconds.**

The ambient temperature measured using an internal temperature sensor is displayed.



4. **Press the MEAS switch to return the measurement mode.**

7.3 Calibration point setting

Used to select the calibration points.

1. Press and hold the MEAS switch for over 3 seconds in the measurement mode to enter the special setting mode.

All items appear on the LCD, and then the display changes as shown right.

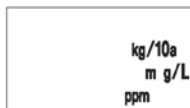

2. Press the CAL switch until CAL appears.

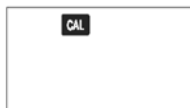

3. Press the MEAS switch for 0.5 seconds.

The current setting is displayed.

4. Press the CAL switch for 0.5 seconds to change the setting.

Pressing the CAL switch continuously switches the display in turn.

One-point calibration
in high concentration

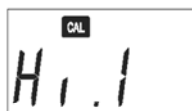

Press the CAL switch
for 0.5 seconds.

Press the CAL switch
for 0.5 seconds.

One-point calibration
in low concentration

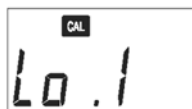

Two-point calibration



Press the CAL switch
for 0.5 seconds.

5. Press the MEAS switch to apply the setting.

The measurement mode is returned.

7.4 Multiplying compensation setting

Used to select the coefficient (0.01 to 9.90) for multiplying compensation. The values after compensation are displayed as results. The initial setting is 1.00.

If the sample is diluted/condensed, change this setting as necessary.

Note

The multiplying compensation function does not change the specified measurement range or product performance.

1. Press and hold the MEAS switch for over 3 seconds in the measurement mode to enter the special setting mode.

All items appear on the LCD, and then the display changes as shown right.

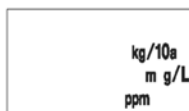

2. Press the CAL switch until MEAS and A appear.



3. Press the MEAS switch for 0.5 seconds.

The current setting is displayed.

4. Press the CAL switch for 0.5 seconds to increase the value.

Pressing the CAL switch continuously increases the value in turn.

Pressing the CAL switch with 9.90 displayed returns the value to 0.01.

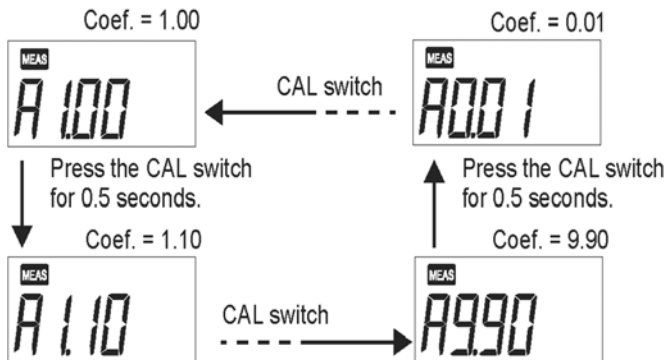

5. Press the MEAS switch to apply the setting.

The measurement mode is returned.

7.5 Adding compensation setting

Used to select the coefficient (-1000 to 1000) for adding compensation. The values after compensation are displayed as results. The initial setting is 0. If measurement is affected by a known factor, change this setting as necessary.

Note

The adding compensation function does not change the specified measurement range or product performance.

1. Press and hold the MEAS switch for over 3 seconds in the measurement mode to enter the special setting mode.

All items appear on the LCD, and then the display changes as shown right.

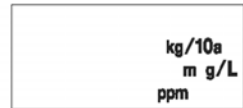

2. Press the CAL switch until MEAS and b appear.
3. Press the MEAS switch for 0.5 seconds.



4. Press the CAL switch for 0.5 seconds to increase the value.
Pressing the CAL switch continuously increases the value in turn. Pressing the CAL switch with 1000 displayed returns the value to -1000.

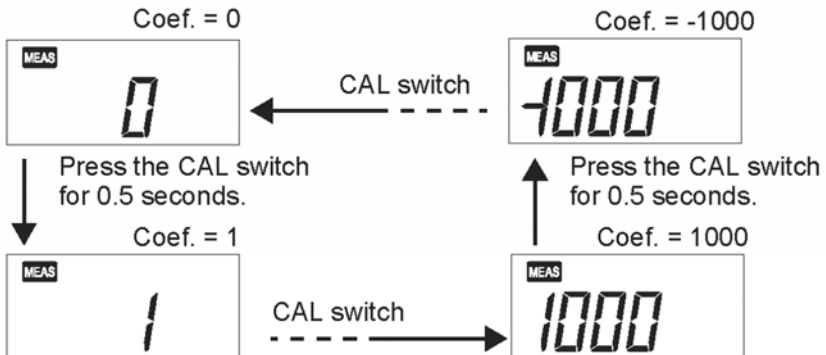

5. Press the MEAS switch to apply the setting.
The measurement mode is returned.

7.6 Sensor voltage display mode

Displays the voltage output from the sensor.

Use this function to evaluate the sensor performance or to create your own calibration line or curve.

- 1. Press and hold the MEAS switch for over 3 seconds in the measurement mode to enter the special setting mode.**

All items appear on the LCD, and then the display changes as shown right.

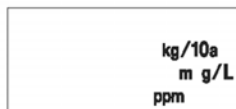

- 2. Press the CAL switch until mV appears.**



- 3. Press the MEAS switch for 0.5 seconds.**

The voltage output from the sensor is displayed.



- 4. Press the MEAS switch to return the measurement mode.**

7.7 Low calibration value setting

Used to change calibration value (39 ppm to 1900 ppm) for low concentration. The initial setting is 150 ppm. If you prepare a calibration solution originally, change this setting as necessary.

Note

If this setting is changed from the default value, measurement results may not meet the specified reproducibility. Perform calibration at a concentration near the sample to be measured.

1. Press and hold the MEAS switch for over 3 seconds in the measurement mode to enter the special setting mode.

All items appear on the LCD, and then the display changes as shown right.

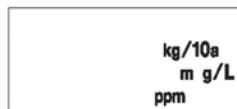

2. Press the CAL switch until Lo.ch appears.



3. Press the MEAS switch for 0.5 seconds.

The current setting is displayed.

4. Press the CAL switch for 0.5 seconds to increase the value.

Pressing the CAL switch continuously increases the value in turn.

Pressing the CAL switch with 1900 displayed returns the value to 39.

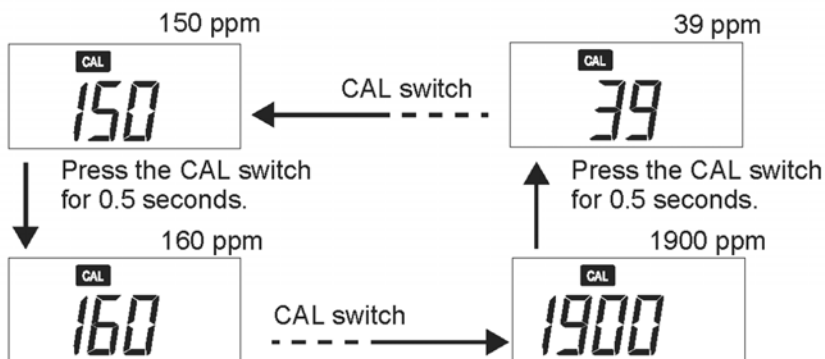

5. Press the MEAS switch to apply the setting.

The measurement mode is returned.

7.8 Initialization mode

All settings and all calibration data are reset to the factory default values.

1. **Press and hold the MEAS switch for over 3 seconds in the measurement mode to enter the special setting mode.**

All items appear on the LCD, and then the display changes as shown right.



2. **Press the CAL switch until Init appears.**



3. **Press the MEAS switch for 0.5 seconds.**

☺ appears.

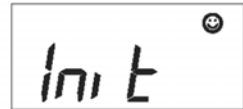

4. **Press the CAL switch for over 2 seconds.**

All settings and all calibration data are reset to the factory default values.

When initialization is completed, End and ☺ appear.



5. **Press the ON/OFF switch to turn OFF and ON again.**

7.9 Software version display mode

The current software version is displayed.

This information may be asked for depending on your inquiry.

1. **Press and hold the MEAS switch for over 3 seconds in the measurement mode to enter the special setting mode.**

All items appear on the LCD, and then the display changes as shown right.

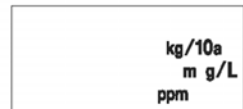

2. **Press the CAL switch until Init appears.**

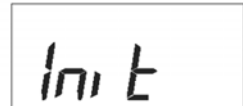

3. **Press the CAL switch for 0.5 seconds.**

The software version is displayed.



8 Appendix

8.1 Frequently asked questions

Question	Answer
How long is the sensor's service life?	It depends on measurement samples and conditions. It should be approx. 1500 measurements for typical samples. Note that sensor deterioration and failure are not included in the warranty.
How can I check the sensor's condition?	Perform two-point calibration. If calibration error occurs, the sensor is deteriorated. Replace the sensor.
What shall I do if two-point calibration is failed?	Dirt in the response membrane and liquid junction is the main cause of calibration failure. Clean the sensor thoroughly with water, then gently wipe off the response membrane with soft cloth or paper. If calibration is still failed after this, replace the sensor.
What factors interfere measurement?	Strong acids and strong alkalis influence measurement results. Measure within the range from 2 pH to 9 pH. Also, high-level monovalent cations, such as NH_4^+ , may cause measurement errors. Refer to page 29 for details.
How can I eliminate or reduce the measurement interference?	Diluting the sample to a concentration within the measurable range can sometimes reduce measurement interference.
Are there any helpful tips or precautions to be aware for measurement?	Use the light shield cover to avoid direct sunlight during measurement because the sensor is affected by light. If the light shield cover is unavailable, for example, when a sampling sheet holder cover is attached, shield the flat sensor from light with an alternative.
	When the sample amount is enough, washing the sensor twice or so with the sample allows more accurate measurement.
	Residue between the light shield cover and flat sensor prevents accurate measurement. Before measurement of the next sample, clean the sensor with tap water and remove moisture.
Can I measure high- or low-temperature samples?	This product can not measure a sample with a temperature outside the meter's operating temperature range (5°C to 40°C). The difference between the sample temperature and ambient temperature increases the measurement error. Perform measurement after the sample reaches the ambient temperature.

Question	Answer
Can I prepare standard solutions myself?	You can prepare standard solutions by dissolving potassium chloride in ion-exchanged water to the specified concentration.
The measured value does not change after changing the sample.	If MEAS lights steadily, the measured value is locked. Press the MEAS switch to unlock the value. If the value does not change after unlocking, the sensor may be damaged. Replace the sensor.
The temperature alarm icon blinks during measurement.	The measuring environment temperature may not meet the specified operating temperature (5°C to 40°C). When the environment temperature is within the specified range and the alarm icon blinks, replace the sensor.
The power is not turned ON.	Check that the batteries are inserted properly. If the batteries are low, replace them both with new ones at the same time.
Er1 is displayed right after power ON.	The internal IC in the meter may defect. After Er1 is displayed, the meter enters the initialization mode automatically and Init and ☺ appear. Press the CAL switch for over 2 seconds to execute initialization, and then turn OFF and ON again (refer to page 25). If Er1 is still displayed after the initialization, the internal IC in the meter defects. Replace the product with new one (the meter can not be repaired).
Er2 is displayed right after power ON.	The internal IC in the meter defects. Replace the product with new one (the meter can not be repaired).
Er3 is displayed right after power ON.	The internal IC in the meter defects. Replace the product with new one (the meter can not be repaired).
How can I return all the settings of the special setting mode to the default settings?	Perform initialization (refer to page 25).

8.2 Specifications

Model		B-731
Measurement principle		Ion electrode method
Minimum sample volume		0.3 mL or more *1
Measurement range	K ⁺	39 ppm (mg/L) to 3900 ppm (mg/L) 20 kg/10a to 2000 kg/10a*2
Display range		0 ppm to 9900 ppm*3
Range and resolution (valid digits)		(1) 0 ppm to 99 ppm: 1 ppm (2) 100 ppm to 990 ppm: 10 ppm (3) 1000 ppm to 9900 ppm: 100 ppm
Calibration		Two-point*4
Accuracy		±10% of reading value*5
Display		Custom (monochrome) digital LCD
Operating temperature/humidity		5°C to 40°C, 85% or less in relative humidity (no condensation)
Power		CR2032 batteries (×2)
Battery life		Approx. 400 hours in continuous use
Main materials		ABS epoxy
Outer dimensions/ mass		164 mm × 29 mm × 20 mm (excluding projections) Approx. 50 g (meter only, without batteries)
Main functions		Auto range change, temperature compensation (2%/°C fixed), waterproof*6, reading locking, automatic power OFF

*1 0.05 mL or more if the sampling sheet B is used.

*2 Only for the sample extracted in the proportion of 1 part of soil to 5 of water.

*3 When the measured value is out of the measurement range, the displayed value blinks. It should be used only as a guide.

*4 Selectable between one-point and two-point calibrations.

*5 Repeatability in measurement of a standard solution after calibration using the same standard solution

*6 IP67: no failure when immersed in water at a depth of 1 meter for 30 minutes. But the product can not be used underwater.

8.3 Interfering ions

Target	Sodium ion (Na ⁺)	Potassium ion (K ⁺)	Nitrate ion (NO ₃ ⁻)	Calcium ion (Ca ²⁺)
Interfering ions and selectivity coefficients	K ⁺ , Rb ⁺ : 1×10^{-2} Ba ²⁺ , Sr ²⁺ , Ca ²⁺ , Mg ²⁺ : 1×10^{-4} Li ⁺ : 1×10^{-3} Cs ⁺ : 3×10^{-3} NH ₄ ⁺ : 6×10^{-3} (at 10 ⁻³ mol/L Na ⁺)	Rb ⁺ : 1×10^{-1} Mg ²⁺ : 1×10^{-5} NH ₄ ⁺ : 7×10^{-3} Ca ²⁺ : 7×10^{-7} Cs ⁺ : 4×10^{-3} Na ⁺ : 3×10^{-4} (at 10 ⁻³ mol/L K ⁺)	I ⁻ : 10 Cl ⁻ : 4×10^{-2} Br ⁻ : 9×10^{-1} ClO ₄ ⁻ : 3×10^{-3} NO ₂ ⁻ : 7×10^{-1} (at 10 ⁻³ mol/L NO ₃ ⁻)	Na ⁺ , K ⁺ , Mg ²⁺ : 1×10^{-3} Fe ²⁺ , Zn ²⁺ : 1 Fe ³⁺ : 10 Cu ²⁺ : 1×10^{-2} (at 10 ⁻³ mol/L Ca ²⁺)
pH range	3 pH to 9 pH (at 10 ⁻³ mol/L Na ⁺)	2 pH to 9 pH (at 10 ⁻³ mol/L K ⁺)	3 pH to 8 pH (at 10 ⁻³ mol/L NO ₃ ⁻)	4 pH to 12 pH (at 10 ⁻³ mol/L Ca ²⁺)

Selectivity coefficient is a concentration ratio of the interfering ion against the target ion, which affects the target ion measurement value. For example, selectivity coefficient of potassium ion against sodium ion is 1×10^{-2} , which means for the same concentration of potassium ion and sodium ion coexisting in a sample, the sodium measurement shows approximately 1×10^{-2} (1%) higher result.

SOIL TEST INSTRUCTIONS

Soil testing of mineral soil requires the Soil Test Kit. A starter kit is included with the LAQUA K⁺ meter #2400GL. Additional supplies can be ordered through a distributor or by calling Spectrum Technologies directly.

Measurement Procedure:

1. Measure 1 level measuring spoon (11cc) full of dry soil into the soil sample cup. The soil should be pulverized and sifted through a flour sifter.
2. Add “2” (50cc) measuring spoons of aluminum sulfate extractant to the soil.
3. Mix the soil and the solution by stirring with the spoon for at least 2 minutes, making sure the soil sample is thoroughly mixed with the distilled water. Let stand for 5 minutes
4. Fold a circular filter in half ‘twice’ and open it up to form a cone. Place it in the soil suspension as far as possible. The filtration will take place from the outside of the filter to the inside.
5. As soon as sufficient filtrate accumulates in the filter, use the small pipette to transfer the soil extract onto the sensor of the LAQUA Meter.
6. After the value has stabilized (30 - 45 sec.), read the value from the digital display. Multiply the display value by 10 to correct for the dilution. For lbs/acre, multiply by 2.
7. Rinse sensor and blot dry. Display should read “0” with distilled water on it. If it doesn’t, rinse again.

MEASUREMENT OF TISSUE SAP

Sample Collection:

When conducting a test on plant materials, the biggest source of error is due to sampling. This error results when a sample is not representative of the source. Follow these steps to gather and care for your sample:

- 1.) Do not sample plants which show obvious signs of nutrient deficiency or damage from disease, insects, or chemicals unless these plants are the subject of a study. Plants which have been under stress for a period of time may not give a true picture of the nutrient status of the field.
- 2.) The leaves or parts of leaves selected should be of the same age and relative position on the plant. The most recently matured leaves should be used. These are the leaves that have stopped expanding in size. The petiole or leaf stem of the leaf or appropriated plant material should be used for the test.
- 3.) A minimum of 25 petioles or leaves should be collected. This is enough to represent a five to ten acre field if the field is judged to be uniform. Chop up the petioles and mix and sub-sample these pieces for testing. Crops with small, dry petioles, such as strawberries require much larger samples to get enough sap compared to fleshy crops such as tomatoes. Store whole petioles, not leaves, at room temperature for up to 1½ hours or on ice for up to eight hours. Cold petioles should be warmed to room temperature before taking a measurement.

PETIOLE POTASSIUM SUFFICIENCY LEVELS

(SOURCE: UNIVERSITY OF FLORIDA)

Crop	Growth Stage	K (ppm)
Tomato (field)	First Buds	3500-4000
	First Open Flowers	3500-4000
	First 1-inch Diameter	3000-3500
	First 2-inch Diameter	3000-3500
	First Harvest	2500-3000
	Second Harvest	2000-2500
Tomato (Greenhouse)	Transplant to second fruit cluster	4500-5000
	Second cluster to fifth fruit cluster	4000-5000
	Harvest Season (Dec. -June)	3500-4000
Bell Pepper	First Flower Buds	3200-3500
	First Open Flowers	3000-3200
	Fruits Half-Growth	3000-3200
	First Harvest	2400-3000
	Second Harvest	2000-2400
Eggplant	First Fruit (2-inches long)	4500-5000
	First Harvest	4000-4500
	Mid Harvest	3500-4000
Potatoes	Plants 8-inches Tall	4500-5000
	First Open Flowers	4500-5000
	50% of Flowers Open	4000-4500
	100% of Flowers Open	3500-4000
	Tops Falling Over	2500-3000

SUFFICIENCY LEVELS CONTINUED:

Crop	Growth Stage	K (ppm)
Annual Hill Strawberries	November	3000-3500
	December	3000-3500
	January	2500-3000
	February	2000-2500
	March	1800-2000
	April	1500-2000
Watermelon	Vines 6-inches Long	4000-5000
	Fruit 2-inches Long	4000-5000
	Fruit One-Half Mature	3500-4000
	At First Harvest	3000-3500

WARRANTY

This product is warranted to be free from defects in material or workmanship for one year from the date of purchase. During the warranty period Spectrum will, at its option, either repair or replace products that prove to be defective. This warranty does not cover damage due to improper installation or use, lightning, negligence, accident, or unauthorized modifications, or to incidental or consequential damages beyond the Spectrum product. Before returning a failed unit, you must obtain a Returned Materials Authorization (RMA) from Spectrum. Spectrum is not responsible for any package that is returned without a valid RMA number or for the loss of the package by any shipping company.



The Manufacturer's **DECLARATION OF CONFORMITY** certifies conformity to the following:

Model Number:	2400GL
Description:	LAQUA Twin Potassium Meter
Type:	Portable Test and Measurement Equipment
Directive:	2004/108/EC
Standards:	EN 61326-1 (2006), Class B

Spectrum[®]
Technologies, Inc.

**3600 Thayer Court
Aurora, IL 60504
(800) 248-8873 or (815) 436-4440
Fax (815) 436-4460
E-Mail: info@specmeters.com
www.specmeters.com**